

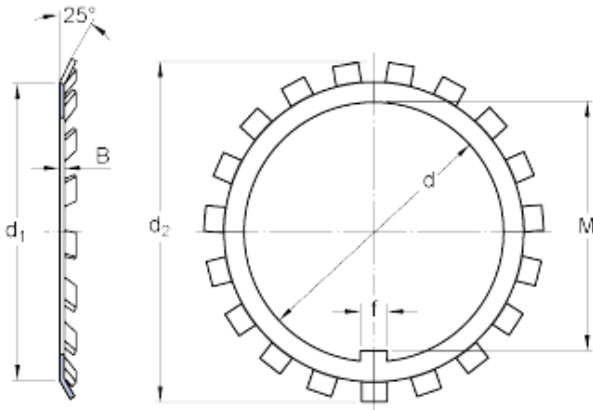

BEARINGS(UK)LTD.



skf MB 4 A Lock nuts requiring a keyway, MB(L)
lock washers

Bearing No. MB 4 A

d	20 mm
d ₁	26 mm
d ₂	36 mm
B	1.2 mm
f	4 mm
M	18.5 mm
Mass lock washer	0.005 kg

MB 4 A Bearing 2D drawings and 3D CAD models