

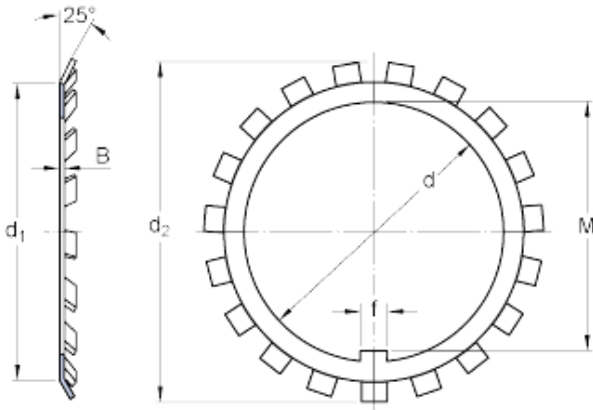

BEARINGS(UK)LTD.



skf MBL 40 Lock nuts requiring a keyway,MB(L) lock washers

Bearing No. MBL 40

d	200 mm
d ₁	222 mm
d ₂	245 mm
B	2.5 mm
f	20 mm
M	194 mm
Mass lock washer	0.22 kg

MBL 40 Bearing 2D drawings and 3D CAD models