

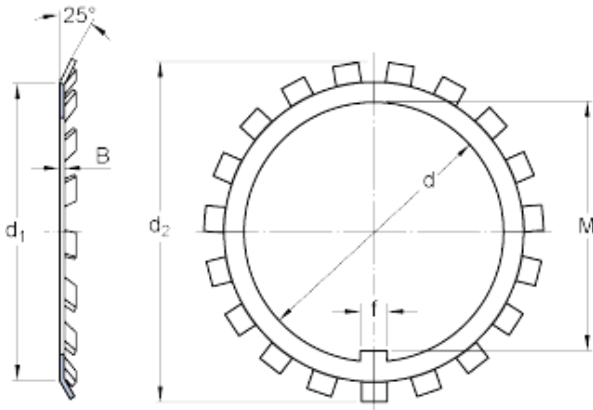

# BEARINGS(UK)LTD.



skf MB 12 A Lock nuts requiring a keyway, MB(L) lock washers

Bearing No. MB 12 A

d	60 mm
d <sub>1</sub>	73 mm
d <sub>2</sub>	86 mm
B	2.5 mm
f	8 mm
M	57.5 mm
Mass lock washer	0.04 kg

MB 12 A Bearing 2D drawings and 3D CAD models