

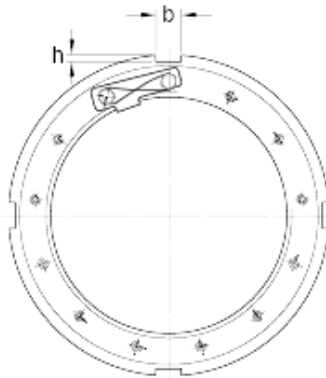

# BEARINGS(UK)LTD.

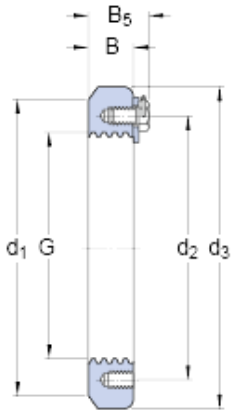

skf N 530 Lock nuts requiring a keyway (inch)

Bearing No. N 530

G	530.022 mm
Threads per inch	4
d <sub>1</sub>	590.55 mm
d <sub>2</sub>	593.344 mm
d <sub>3</sub> max.	630.377 mm
B	68.656 mm
B <sub>5</sub>	82.55 mm
b	40.767 mm
h	20.904 mm
Mass lock nut	52.5 kg
Associated spanner	TMFN 80-500
Locking device	PL 530
Hexagonal head bolt	5/8-11x1-1/4

N 530 Bearing 2D drawings and 3D CAD models