

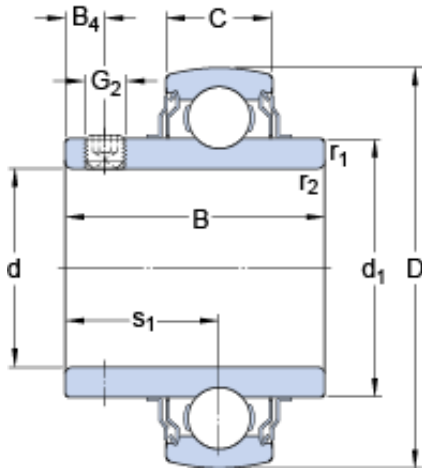

BEARINGS(UK)LTD.



45 mm x 85 mm x 49.2 mm skf YAR
209-2FW/VA201 Insert bearings with grub screws
for high temperature applications

Bearing No. YAR 209-2FW/VA201

Size	85x45x49.2 mm
Bore Diameter	85 mm
Outer Diameter	45 mm
Width	49,2 mm
d	45 mm
D	85 mm
B	49.2 mm
C	22 mm
d ₁	56.8 mm
B ₄	8 mm
s ₁	30.2 mm
r _{1,2} - min.	1 mm
Basic dynamic load rating - C	33.2 kN
Basic static load rating - C ₀	21.6 kN
Limiting speed	60 r/min
Limiting temperature - T	250 ° C
Mass bearing	0.6 kg
Grub (set) screw - G ₂	M8x1
Hexagonal key size for grub screw - H	4 mm
Category	Bearings
Inventory	0.0
Manufacturer Name	SKF

YAR 209-2FW/VA201 Bearing 2D drawings and 3D CAD models



BEARINGS(UK)LTD.

Minimum Buy Quantity	N/A
Weight / Kilogram	0
Product Group	M06110
d_1	56.8 mm
B_4	8 mm
s_1	30.2 mm
$r_{1,2}$ min.	1 mm
Basic dynamic load rating C	33.2 kN
Basic static load rating C_0	21.6 kN
Limiting temperature T max.	250 ° C
Grub (set) screw G_2	M8x1
Hexagonal key size for grub screw N	4 mm
Recommended tightening torque for grub screw	6.5 N · m