

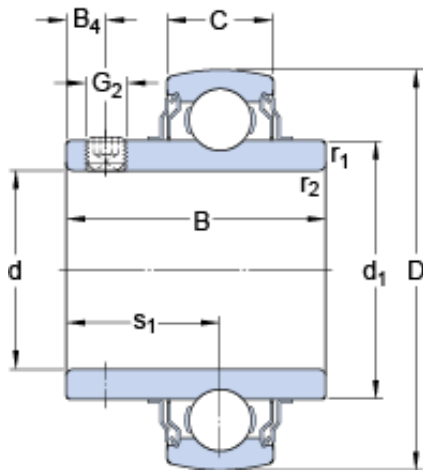

BEARINGS(UK)LTD.



34.925 mm x 72 mm x 42.9 mm skf YAR
207-106-2FW/VA201 Insert bearings with grub
screws for high temperature applications

Bearing No. YAR 207-106-2FW/VA201

Size	72x34.925x42.9 mm
Bore Diameter	72 mm
Outer Diameter	34,925 mm
Width	42,9 mm
d	34.925 mm
D	72 mm
B	42.9 mm
C	19 mm
d ₁	46.1 mm
B ₄	6 mm
s ₁	25.4 mm
r _{1,2} - min.	1 mm
Basic dynamic load rating - C	25.5 kN
Basic static load rating - C ₀	15.3 kN
Limiting speed	80 r/min
Limiting temperature - T	250 ° C
Mass bearing	0.46 kg
Grub (set) screw - G ₂ - 5/16-24 UNF	5/1624 UNF
Hexagonal key size for grub screw - H	3.969 mm
d ₁	46.1 mm
B ₄	6 mm
s ₁	25.4 mm

YAR 207-106-2FW/VA201 Bearing 2D drawings and 3D
CAD models



BEARINGS(UK)LTD.

$r_{1,2}$ min.	1 mm
Basic dynamic load rating C	25.5 kN
Basic static load rating C_0	15.3 kN
Limiting temperature T max.	250 ° C
Grub (set) screw G_2	5/16-24 UNF
Hexagonal key size for grub screw N	3.969 mm
Recommended tightening torque for grub screw	6.5 N · m